

COBRA

MADE IN JAPAN

Operator's manual

LAWN MOWER

TN 2160SXAH-PRO

CE

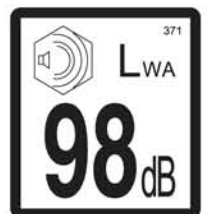
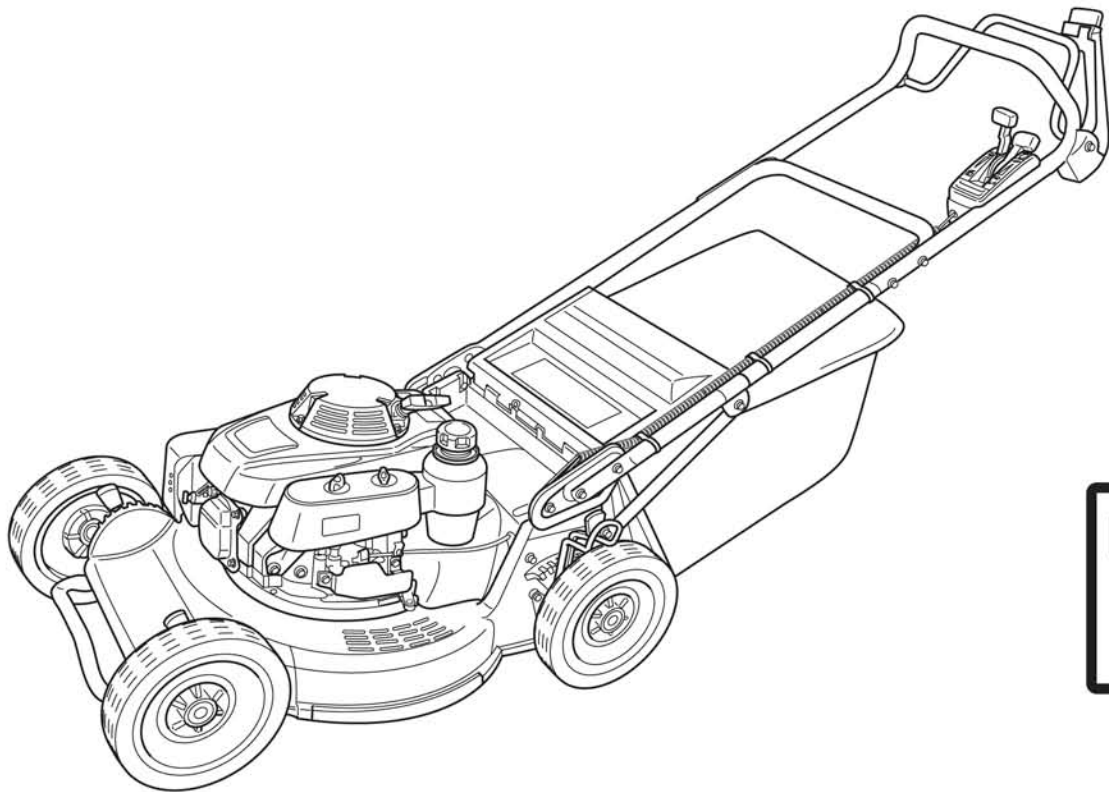

Read the following instructions before use.

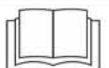

TABLE OF CONTENTS

1. INTRODUCTION	1
2. ABOUT THIS MANUAL	1
3. SAFETY	1
4. NAME AND FUNCTION OF EACH PART	3
5. TECHNICAL DATA	4
6. ITEMS IN THE PACKAGE	4
7. ASSEMBLY	5
8. OPERATION	6
9. INSPECTION AND MAINTENANCE	9
10. TRANSPORTATION	10
11. LONG-TERM STORAGE	10
12. DISPOSAL	10
13. TROUBLESHOOTING	10

1. INTRODUCTION

(Be sure to read this manual before using the machine!)



- Thank you very much for purchasing our Lawn Mower.
- Before operating the machine, be sure to carefully read all the manuals including this manual to understand their contents.
- If the machine is operated without fully understanding their contents, an unexpected personal accident may occur or the machine or other property may be damaged since you are not aware of the hazards involved in the machine and the safety measures to avoid them.
- Acknowledge that we cannot guarantee any damage occurred due to your failure to follow the contents in this manual.
- Never allow any child to operate or service this machine.

2. ABOUT THIS MANUAL

- Consult our distributor when you have lost or damaged this manual.
- The illustrations and contents in this manual may differ from the actual machine due to the revision of the specifications, etc.
- Attach this manual to the machine when you lend or resell the machine to other person.

CAUTION

Carefully follow the instructions below to avoid any mistakes. We shall not be held responsible for any accident due to any operational error resulting from negligence in following the instructions, nor for any accident due to repair, remodeling, overhaul, etc., by anyone but our authorized dealers.

3. SAFETY (Be Sure To Read!)

Strictly observe the contents in this section and the warnings in each section, and never take any general dangerous behavior.

3.1 Safety alert symbol

This is the safety alert symbol. When you see this symbol in this manual, be alert and avoid personal injury. When accompanied by the words "CAUTION" & "WARNING", it calls your attention to items or operations which can lead to serious injury.

3.2 Signal Words for Safety

In this manual, the following signal words are used for the safety precautions considered to be especially important.

WARNING You should pay special attention to these instructions since failure to do so could result in injury or death to the operator.

CAUTION Instructions which, if not followed, could result in mechanical damage or failure.

NOTE This symbol refers to an area or subject of special merit emphasizing either the product's capabilities, common errors in operation, maintenance and instructions which are of special interest.

3.3 Safety Labels

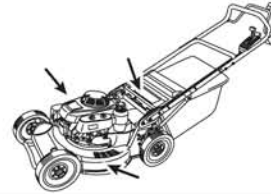

	WARNING! : READ INSTRUCTION HANDBOOK!
	WARNING! : KEEP BYSTANDERS AWAY!
	WARNING! : KEEP HANDS AND FEET AWAY FROM THE BLADES!
	RISK OF ROTATING BLADE : DISCONNECT THE SPARK PLUG CAP BEFORE MAINTENANCE OR REPAIR.
	ALWAYS WEAR EYE AND EAR PROTECTORS WHEN USING THIS UNIT.

3.4 Precautions on Blade

This machine is equipped with the blade that rotates at high speed. (See Section 9.7)

It is very dangerous if you work without observing the following precautions since the blade is a sharp-edged, dangerous cutter.

WARNING

- Do not insert your hand or foot from the gap under the cover while the engine is working.
- Stop the engine and remove the plug cap in the following situations: During inspection and maintenance, and part replacement, and at a machine trouble or other trouble (such as the case being coughed by a branch, etc.)



3.5 Handling of Gasoline

Observe the following precautions to prevent an accident when handling gasoline.

WARNING (See the separate engine manual.)

Fuel to be used

- Use unleaded gasoline only.
- Do not use any gasoline such as the one with alcohol, lead gasoline, and dirty gasoline.
- Besides, do not mix oil to it.
- If fuel other than gasoline is used, it may cause a fire or damage the machine.

Refueling

- Gasoline is highly combustible and explosive, and, therefore, do not get any cigarette and other combustible items close to it. Also, never refuel near a place where fire is used.
- Do not open the fuel tank cap nor refuel while the engine is working or it is still hot.
- Surely tighten the fuel tank cap. If gasoline is spilt, immediately wipe it off with a rag. Also, do not bring any ignition source closer until it vaporizes.
- Take caution not to mix foreign matters.
- Check for fuel leakage.
- Be sure to ventilate when refueling gasoline indoors. Refuel at a properly ventilated place.

Storage

- Put in a (metallic) container only for gasoline, and keep it in a cool dark place.
- Keep it distinguished from kerosene, etc.
- Store only the amount of gasoline regulated by the relative law of a country where this machine is to be used.



3.6 General Safety Rules

3.6.1 Before Use

⚠ WARNING

Do not start the engine indoors or at a place not ventilated well. Concentrated harmful carbon monoxide will cause gas poisoning.



- Confirm that parts are firmly assembled. Especially, check the blade carefully. (See Section 9.7)
- Adjust the height of the handle to avoid uncomfortable posture.
- Use this machine at ambient temperatures between 5°C and 40°C. Failure to use this machine within this temperature range may result in malfunction, breakdown, or accident.
- Inspection of the mowing area and the need remove to foreign objects which may be thrown by the machine (stones, toys, sticks, wires, etc...).
- Wear a long sleeve cloth and long trousers not loose.
- Do not use the machine with bare foot or with sandals on.
- Do not use the machine after you drink alcohol or take a medicine or when you feel unhealthy because of a cold, etc.
- Do not work for a long time under hot weather.
- Do not use lawn mower when there is a risk for lightning.

3.6.2 During Use

⚠ WARNING

- Do not insert your foot or hand from the gap under the housing. (See Section 4.2)
- Do not allow any child to step into the mowing area.
- Always stop the engine and remove the ignition plug when attaching or detaching the grass bag or adjusting the mowing height.
- If you have noticed abnormal vibration, sound, or smell during use or hit some hard object such as a stone, immediately stop the engine and remove and check the ignition plug.

- Do not allow any other persons to get close to the machine. Always stop the blade if other person approaches.
- Do not plug the outlet of the muffler.
- Take special caution when mowing a grass at un-flat places. The lawn mower may incline, making the blade visible and kicking about grass and stones.
- When using on a slope, mow across it. Never mow upward along the slope.
- Take special caution when changing the mowing direction on a slope.
- Do not use the machine on a steep slope.
- Use the machine in the bright daytime or under sufficiently bright lighting.
- Do not use the machine for wet grass. Otherwise, you may slip and fall.
- Firmly grab the handle with both hands and watch out your steps. Never run while using the machine.
- Release (disengage) the drive clutch lever and the blade lever when starting the engine.
- Do not have access to the rotating parts with your hand or foot.
- Do not lift the machine while the engine is working.
- Do not use the machine with the guard removed or open.
- Always stop the engine when leaving the machine unattended.
- Always stop the blade when not using the machine while you move to other mowing area.

3.6.3 After Use

After use, remove the grass or refuse from the machine and check for lost parts or abnormalities.

3.6.4 Inspection and Maintenance

⚠ WARNING

- Do not start the engine indoors or at a place not ventilated well. Concentrated harmful carbon monoxide will cause gas poisoning.
- When performing inspection, maintenance, repair, or cleaning, stop the engine and remove the plug cap.
- Wear eye protectors when grinding the blade.

- Wear leather gloves when checking the blade.
 - Take caution not to get burnt when removing the plug cap.
 - Service the engine after it has cooled down.
 - Take caution not to spill gasoline or oil when leaning this machine. If spilt, immediately wipe off with a rag.
 - Do not use this machine if there are some tears or damages. Do not repair parts. Instead, exchange them.
- Use only the parts specified by us. Also, use only the blade specified by us.
- Parts of an unequal quality, if used, may damage the machine and impair safety.

3.6.5 Transportation by Car

⚠ WARNING

- Stop the engine.
- Fix this machine with ropes so that its handle does not project from the loading platform.
- When using a running board for loading or unloading of the machine, use the one with sufficient strength, width, and length, and skids and hooks.
- Do not lift this machine by yourself. Lift it by two workers.
- Wear slip-less gloves.
- Avoid jack-rabbit starts, rapid acceleration, and quick stops when driving a car.

3.6.6 Engine

- See the separate engine instruction manual for the information on the engine.
- Stop the engine by setting the throttle lever to "N" if it does not stop with the lever at "STOP" position.

3.6.7 Others

⚠ WARNING

- Keep the machine out of reach of children.
 - Do not modify this lawn mower.
 - Do not use the machine for any purpose other than mowing a lawn.
- Do not accumulate any flammable refuse such as grass on the engine (to prevent a fire) since it becomes hot.
 - Adjust the mowing height after stopping the engine.
 - Put this machine on a flat place when leaving it unattended or servicing it.

4. NAME AND FUNCTION OF EACH PART

4.1 Purpose of Use

This lawn mower is designed and manufactured to mow a lawn.

4.2 Name and Function of Each Part

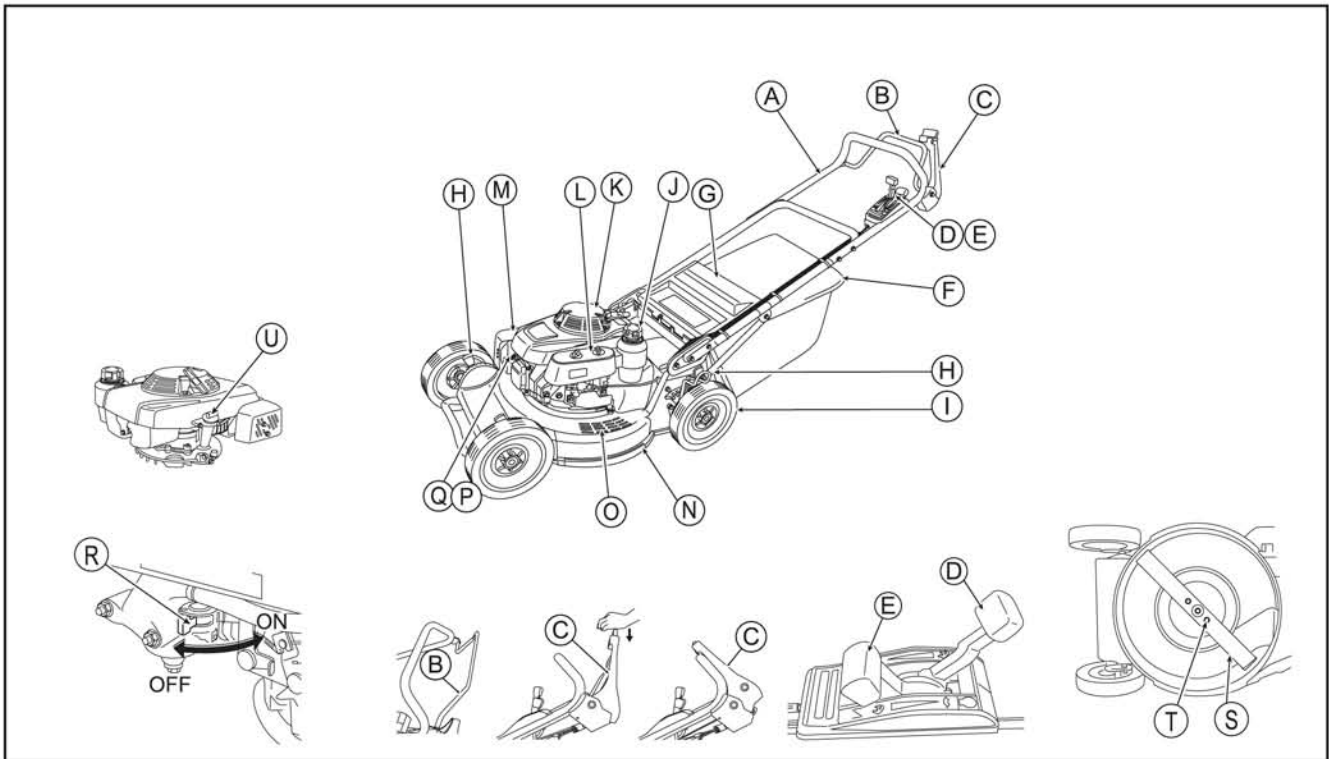

NOTE Illustrations may differ from the actual machine you have purchased.

No.	Name	Description															
A	Handle	Grab this handle when using the lawn mower.															
B	Drive clutch lever	Controls mowing and stoppage. Pushed forward: Starts mowing. Released: Stops mowing.															
C	Blade lever	Rotates and stops the blade. Pushed forward with button pressed: Rotates the blade. (When pushed forward with the button not pressed, the blade does not rotate.) Released: Stops the blade rotation.															
D	Gearshift lever	Adjusts the mowing speed.															
E	Throttle lever	Adjusts the engine speed. <table style="width: 100%; border: none;"> <tr> <td style="text-align: center;">(Position)</td> <td style="text-align: center;">(Meaning)</td> <td style="text-align: center;">(Usage)</td> </tr> <tr> <td style="text-align: center;">" \ " "</td> <td style="text-align: center;">Choking</td> <td style="text-align: center;">Engine start</td> </tr> <tr> <td style="text-align: center;">" ⚙ " "</td> <td style="text-align: center;">High speed</td> <td style="text-align: center;">Mowing</td> </tr> <tr> <td style="text-align: center;">" ⚙ " "</td> <td style="text-align: center;">Low speed</td> <td style="text-align: center;">Idling</td> </tr> <tr> <td style="text-align: center;">" STOP " "</td> <td style="text-align: center;">Stop</td> <td style="text-align: center;">Engine stop</td> </tr> </table>	(Position)	(Meaning)	(Usage)	" \ " "	Choking	Engine start	" ⚙ " "	High speed	Mowing	" ⚙ " "	Low speed	Idling	" STOP " "	Stop	Engine stop
(Position)	(Meaning)	(Usage)															
" \ " "	Choking	Engine start															
" ⚙ " "	High speed	Mowing															
" ⚙ " "	Low speed	Idling															
" STOP " "	Stop	Engine stop															
F	Grass bag	Receives the mown grass.															
G	Guard																
H	Adjustment lever	Adjusts the mowing height. (Mounted at each wheel.)															
I	Wheel																
J	Fuel tank port	Refuels gasoline.															
K	Recoil starter	Pull the knob to start the engine.															
L	Air cleaner																
M	Muffler																
N	Housing																
O	Step	Put your foot when starting up the engine.															
P	Ignition plug																
Q	Plug cap																
R	Fuel cock	Supplies fuel to the engine. "ON": Fuel supply "OFF": Fuel stop															
S	Blade																
T	Blade mounting bolt	Bolts to mount the blade to the machine.															
U	Oil tank cap	Cap for oil filler port with oil gauge.															

5. TECHNICAL DATA

Model	TN2160SXAH-PRO	
Dimensions L x W x H	mm	1 830 x 580 x 1 270
Dry weight	kg	62
Cutting width	cm	53
Cutting height	mm	22 / 32 / 42 / 52 / 62 / 72 / 82
Wheel diameter	mm	244 : 9.6" Aluminum wheel
Grass bag capacity	L	75
Measured sound pressure level at the operator position (in accordance with harmonized standard ISO 5395-1 : 2013, Annex F)	dB[A]	83
Measurement uncertainty	dB[A]	1
Measured sound power level (in accordance with directives 2000/14/EC, 2005/88/EC)	dB[A]	97
Measurement uncertainty	dB[A]	1
Measured vibration level (in accordance with harmonized standard ISO 5395-1 : 2013, Annex G)	m/s ²	3.5
Measurement uncertainty	m/s ²	1.8
Engine	HONDA GXV160	
Engine type	Air-cooled, 4-cycle OHV, Single-cylinder, gasoline engine	
Displacement (Bore x Stroke)	cm ³	163 (68 mm x 45 mm)
Maximum operating engine speed	min ⁻¹	2 800
Nominal power	kW	2.7 (2 800 min ⁻¹)
Maximum torque	Nm	9.6 (2 500 min ⁻¹)
Fuel	Unleaded gasoline for automobiles	
Fuel tank capacity	L	1.8
Recommended engine oil	SAE 10W-30	
Engine oil capacity	L	0.65
Ignition system	Transistorized magneto ignition	
Ignition plug	NGK : BPR 5 ES / DENSO : W16 EPR-U	
Starting method	Recoil method	
Transmission	2-step gearshift mechanical transmission	
Number of speeds	2	
Forward speed	m/s	0.9 (1 : Low speed) / 1.3 (2 : High speed)
Recommended gear oil	ISO VG 220 (SAE 90)	
Gear oil capacity	cm ³	150

The specifications above may change for improvement without prior notice.

6. ITEMS IN THE PACKAGE

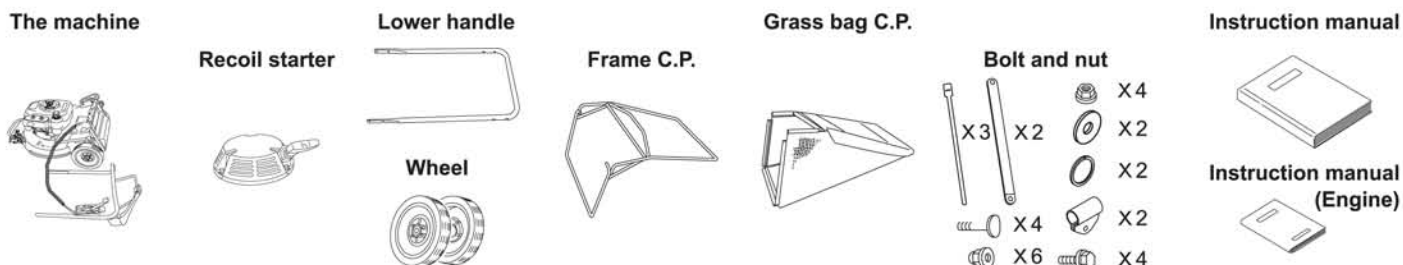

7. ASSEMBLY

7.1 Assembly of Wheel

1. Put the adjuster shaft through the ring.
2. Set a wheel and tighten with a washer and a bolt.

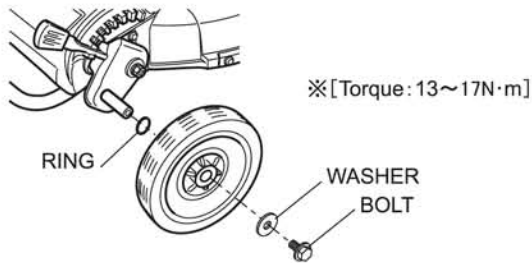

7.2 Assembly and Height Adjustment of Handle

The handle can be adjusted steplessly within its adjustment range.

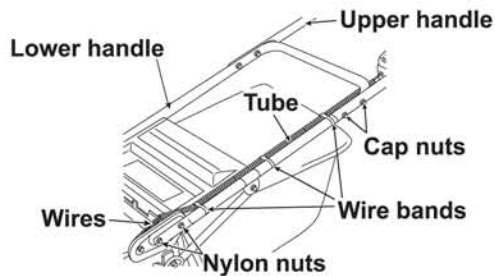

Fig. 1

1. Install the lower handle to the machine (with 4 nylon nuts). (See Figs. 1, 2 and 3)
2. Assemble the upper handle to the lower handle, and then tighten with bolts and cap nuts.
3. Remove the housing bolts and loosely fix the bar temporarily. (See Figs. 4)
4. Install the fixing band to the lower handle.
5. Catch the bar with the hanger band and tighten it with bolts and cap nuts.
6. Tighten the bolts of the housing.

handle height adjust bolt

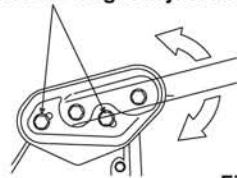

Fig. 2

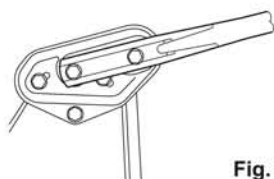

Fig. 3

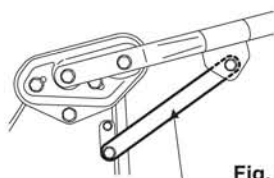

Fig. 4

NOTE

- Fix wires, etc. to the handle with wire bands so that they do not interfere opening / closing of the guard or operation of the machine.
- When adjusting the height of the handle, loosen the bolt of the handle assist bar before loosening the handle height adjust bolt.

7.3 Attaching and Detaching of Grass Bag

CAUTION

Be sure to stop the engine. Open or Close Guard (G) slowly. Also, do not insert your fingers in between.

(See Figs. 5, 6 and 7)

7.3.1 Assembly

1. Lift Guard (G), and set Hook (W) on the housing.
2. Confirm that Grass bag (F) is attached at the specified position.

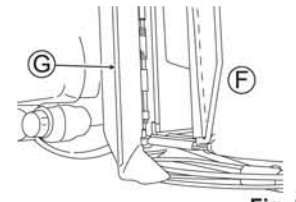

Fig. 5

7.3.2 Removal

1. Lift Guard (G), and remove Hook (W) from the housing.
2. Close Guard (G) slowly.

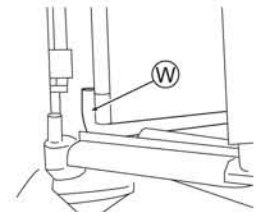

Fig. 6

NOTE

- Clogging of the grass bag lowers the collecting performance.
- A wet grass bag advances clogging.

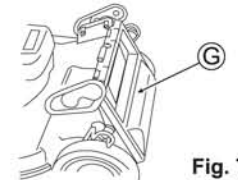

Fig. 7

8. OPERATION

8.1 Preparation and Inspection Before Operation

Place the lawn mower at a level place.

⚠ WARNING

Before inspection, be sure to stop the engine and remove the plug cap.

8.1.1 Checking the engine oil amount

1. Remove Oil tank cap (U), pull out the oil gauge, and then insert it not screwing it. (See Fig. 8)
2. Remove Oil tank cap (U), and confirm that the oil level is between the upper and lower limits of the oil gauge.
3. Replenish oil if oil level is near the lower limit.
4. Firmly close Oil tank cap (U) after confirmation.

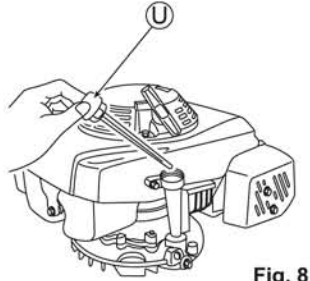

Fig. 8

8.1.2 Recommended Engine Oils

For Lawn Mower with HONDA engine:

Use engine oil of API Class SJ or later.

SAE 10W-30 is generally recommended for the entire temperature range. Select engine oil suitable for the temperature in which the machine is used, referring to Fig 9.

See the instruction manual of the engine for details.

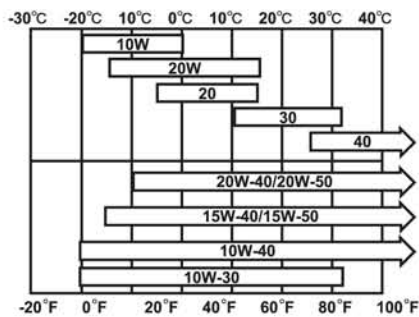

Fig. 9

NOTE

No engine oil is filled before the shipment from our factory. Be sure to fill the engine oil before starting the machine for the first time.

8.1.3 Refueling

(See Section 3.5 for precautions during refueling.)

1. Open Fuel tank cap (J) and refuel gasoline. Immediately wipe off with a rag if gasoline is spilt. (See Fig. 10)
2. Firmly close Fuel tank cap (J) after refueling.

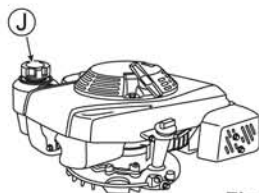

Fig. 10

8.1.4 Checking the grass bag

Confirm that there are no holes and damages with the grass bag. If any, exchange it with new one specified by us.

8.1.5 Checking each part

1. Confirm that all the bolts, nuts, and screws are securely tightened.
2. Confirm that the covers and guards are firmly installed. Remove the drive shaft cover with a tool.
3. See Section 9.7 for the inspection of the blade.

8.2 Start and Stop of Engine

8.2.1 Start

1. Install Plug cap (Q). (See Fig. 13)
2. Set Fuel cock (R) to "ON". (See Fig. 11)
3. Set Throttle lever (E) to Choking "N". (See Fig. 12) (The engine can start by setting the lever at "N" when it is warm.)
4. To start the engine, step one foot on the step of the housing, lightly pull Starter knob (V) and temporarily stop at a position where you feel heavy to pull the knob, and then powerfully pull it from that position. After that, return Starter knob (V) slowly. (See Fig. 13)

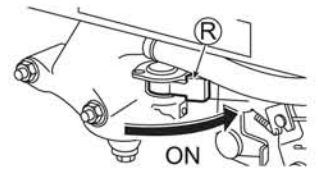

Fig. 11

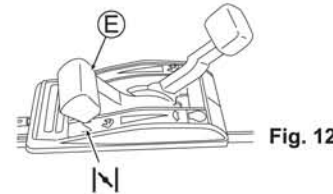

Fig. 12

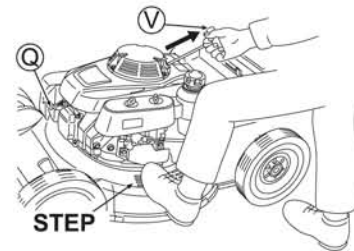

Fig. 13

⚠ CAUTION

- Confirm that there is no person behind you when pulling Starter knob (V).
- Securely grab Starter knob (V) when you pull it.
- Return Starter knob (V) slowly.

5. Warm up the machine before use. After the engine has warmed up, start mowing by setting Throttle lever (E) to "N". (See Fig. 14)

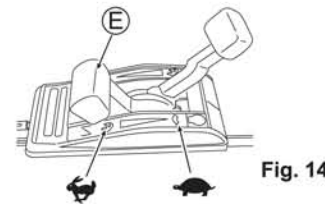

Fig. 14

NOTE

- The engine stalls if the blade lever is gripped with Throttle lever (E) set at "N".

8.2.2 Stop

1. Release the blade lever and the drive clutch lever.
2. Set Throttle lever (E) to "STOP". (See Fig. 15)
3. Set Fuel cock (R) to "OFF". (See Fig. 16)

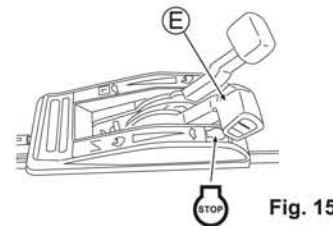

Fig. 15

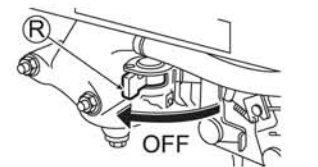

Fig. 16

NOTE

- Do not stop the engine with Throttle lever (E) set at "N". Restarting the engine will become harder. If the engine does not stop even if Throttle lever (E) is set at "STOP", set it to "N".
- The engine stalls if the blade lever is gripped with Throttle lever (E) set at "N".

8.3 Operation (Mowing and Running)

Perform mowing work correctly and safely by observing the instructions in this manual.

Use this machine at ambient temperatures between 5°C and 40°C. Failure to use this machine within this temperature range may result in malfunction, breakdown, or accident.

⚠ WARNING

Before working, fully understand the contents of the safety instructions including those in Section 3.

⚠ CAUTION Operate each lever securely.

1. Perform the inspection before operation. (See Section 8.1)

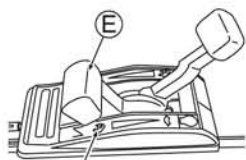

Fig. 17

2. Set Throttle lever (E) to "STOP" to start mowing. (See Fig. 17)

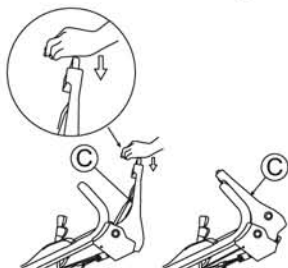

Fig. 18

3. Push Blade lever (C) forward while pressing its yellow button. Then, the blade starts rotating. (See Fig. 18)

4. Push Drive clutch lever (B) forward to start mowing. (See Fig. 19)

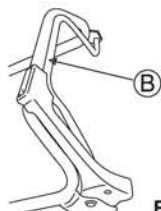

Fig. 19

5. Adjust the mowing speed with Gearshift lever (D). (See Fig. 20)

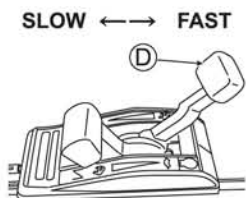

Fig. 20

⚠ CAUTION

Push down each lever until it touches the handle. Continuing to work with each lever not pushed down completely will result in a machine failure.

NOTE

Adjust the mowing speed according to the conditions of the mowing area and the grass.

The blade does not rotate for safety when Blade lever (C) is operated with its button not pressed.

6. To interrupt mowing work halfway or finish it, return Drive clutch lever (B) and Blade lever (C), and then set Throttle lever (E) to "STOP" to stop the engine.

(See Fig. 21)

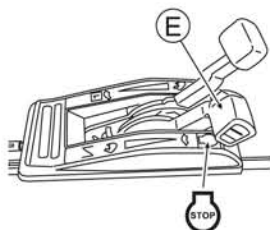

Fig. 21

8.4 Adjustment of Mowing Height

Adjust the mowing height with the mowing height adjustment levers on the wheels.

⚠ CAUTION

Take caution not to touch the muffler and the engine when adjusting the mowing height adjustment levers on the front wheels.

1. Stop the engine.
2. Lean the mowing height adjustment lever (H) toward the wheel side, separating from the notches (dents) (Z). (See Figs. 22 and 23)

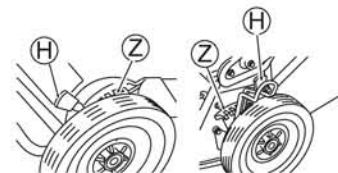

Fig. 22

3. Insert the mowing height adjustment lever (H) into the notch (Z) for the target height with the lever kept leaned.

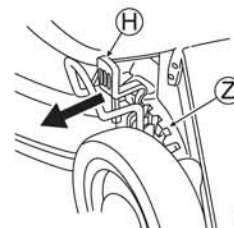

Fig. 23

4. Insert all Mowing height adjustment levers (H) into the notches (Z) of the same height.

8.5 Adjustment of Wires

NOTE

Poor adjustment of each wire will result in the decline of performance or a machine failure.

8.5.1 Throttle Lever (See Figs. 24 and 25)

Adjust Throttle lever (E) so that choking works when it is positioned at "N".

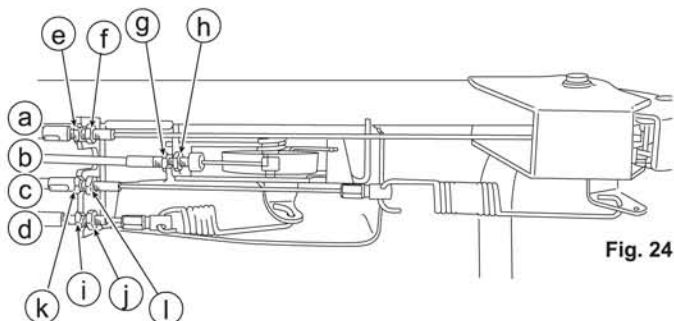

Fig. 24

1. Confirm that the adjustment hole on the engine control panel matches Throttle lever (E) when the lever is set at high speed position "N".

2. If adjustment is necessary, adjust by turning Adjuster (g), loosening Lock nut (h) of Throttle wire (b).

3. Set the adjuster to the optimal position and tighten Lock nut (h).

4. Start the engine and confirm that the engine stops completely when Throttle lever (E) is set at "STOP".

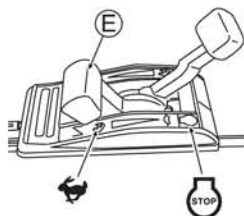

Fig. 25

8.5.2 Blade Lever (See Figs. 24 and 26)

Adjust so that the blade starts rotating when the distance between Blade lever (C) and the handle is 50 - 75 mm with the yellow button pressed as shown in Fig. 26.

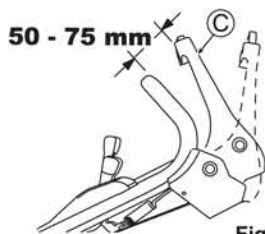

Fig. 26

1. If adjustment is necessary, adjust by turning Adjuster (e), loosening Lock nut (f) of Blade wire (a).
2. Set the adjuster to the optimal position and tighten Lock nut (f).
3. Confirm that the blade stops completely when Blade lever (C) is released.

8.5.3 Drive Clutch Lever (See Figs. 24 and 27)

Adjust so that the machine runs (the drive clutch gets engaged) when the distance between Drive clutch lever (B) and the handle is 75 - 100 mm as shown in Fig. 27.

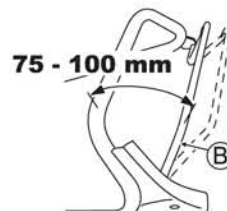

Fig. 27

1. If adjustment is necessary, adjust by turning Adjuster (k), loosening Lock nut (l) of Drive clutch wire (c).
2. Set the adjuster to the optimal position and tighten Lock nut (l).
3. Confirm that the machine can be pull backward when Drive clutch lever (B) is released.

8.5.4 Gearshift Lever (See Figs. 24 and 28)

Adjust the play of Gearshift lever (D) to 1 - 3 mm as shown in Fig. 28.

1. If adjustment is necessary, adjust by turning Adjuster (i), loosening Lock nut (j) of Gearshift wire (d).
2. Set to the optimal position and tighten Lock nut (j).
3. Start the engine and confirm that running speed changes when Gearshift lever (D) is operated.

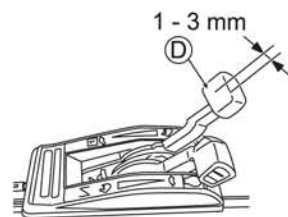

Fig. 28

NOTE

Ask our distributor for adjustment if the machine does not operate properly even after adjusted by the above-mentioned methods.

9. INSPECTION AND MAINTENANCE

NOTE

See the engine instruction manual for the details of the maintenance of the engine.

9.1 Cleaning

- Wipe dirt off when this machine and the safety labels get dirty.
- Do not directly spray water with a hose, etc. since it may cause a machine failure.
- Wipe with a dry rag after cleaning, and then wipe the metal surface with a rag soaked with oil.
- Clean the grass bag while spraying water with a hose. Use it after drying.

9.2 Checklist

Operating hours		Every time	Time		
			25	50	100
Engine oil (8.1.1, 9.4)	Check	○			
	Exchange			○*	
Air cleaner (9.5)	Cleaning		○		
Loose bolt (9.8)	Check	○			
Fuel (8.1.3)	Refueling	○			
Ignition plug (9.6)	Cleaning				○
	Adjust				○
Blade (9.7)	Check	○			
Blade bolt (9.7.1)	Check	○			
Grass bag (8.1.4)	Check	○			
	Cleaning	○			
Throttle wire	Adjust				○
Drive clutch wire	Adjust			○	
Blade wire	Adjust			○	
	Check			○	
Gearshift wire	Adjust			○	
Valve clearance	Adjust				○**
Combustion chamber	Cleaning				○**
Fuel tank	Cleaning				○**
Strainer	Cleaning				○**
Fuel tube	Check				○

* Exchange oil after using the machine for 25 hours only for the first time after purchase.

After that, exchange oil at 50-operating hour intervals according to the degree of dirtiness.

** Maintenance techniques and special tools are necessary for this check item. Therefore, consult our distributor near you.

The numbers in () show the sections in this manual to be referred.

9.3 Lubrication to Each Part

Regularly lubricate each bearing with an oilcan to keep the smooth operation of each part.

9.4 Exchanging Engine Oil

NOTE

Extract gasoline first before tilting the engine to drain its oil. Treat and dispose the drained engine oil properly according to the law in each country.

CAUTION

Take sufficient caution not to get burnt since the engine and the muffler are very hot right after the engine stops.

1. Remove the oil tank cap. (See Section 8.1.1)
2. Drain the engine oil from the drain port. (See Fig. 29)
3. Fill with fresh engine oil after drainage is complete.



Fig. 29

9.5 Air cleaner (See Fig. 30)

1. Remove Mounting bolts (a) and open Cover (b).
2. Clean Element (c) if it is very dirty.
3. Return Element (c) to its original position, and close Cover (b) with Mounting bolts (a).

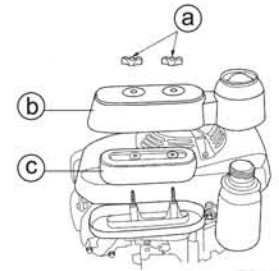

Fig. 30

9.6 Ignition Plug

1. Remove Plug cap (Q). (See Fig. 31)
2. Remove Ignition plug (P) with the attached plug wrench. (See Fig. 32)
3. Exchange Ignition plug (P) if a great amount of carbon is adhered to it or its insulator is cracked or damaged.
4. Remove the carbon adhered to the electrode, and adjust the electrode clearance to 0.7 mm. (See Fig. 33)
5. Install Ignition plug (P) and Plug cap (Q).

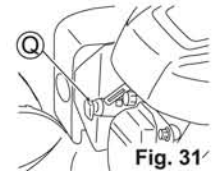

Fig. 31



Fig. 32

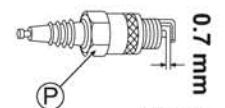

Fig. 33

9.7 Blade

NOTE

Incline this machine with the carburetor side of the engine positioned upside.

9.7.1 Checking the blade mounting bolts

WARNING

Stop the engine and remove the ignition plug when you check the blade.

CAUTION

Wear thick gloves when you check or attach or detach the blade.

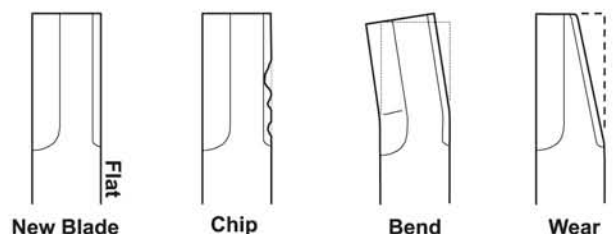

Fig. 34

1. Confirm that there is no chip, bend, or wear with Blade (S). (See Fig. 34)
2. If Blade (S) or its mounting bolts (T) are "worn", "broken" or "deformed", exchange with new one(s) specified by us.
3. Confirm that Blade mounting bolts (T) are tightened by the specified torque. (See Fig. 35)

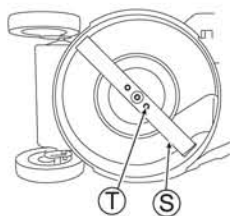

Fig. 35

(Tightening torque of blade mounting bolts (T): 29-39 Nm)

9.7.2 Attaching / Detaching the blade

Detaching

1. Loosen Blade mounting bolts (T), and remove the blade.

Attaching

1. Remove the refuse and grass adhered around the blade mounting bracket and also remove dirt.
2. Fully tighten Blade mounting bolts (T) with hand.
3. Securely assemble the blade.
4. Confirm that Blade mounting bolts (T) are tightened by the specified torque. (See Fig. 35)

(Tightening torque of blade mounting bolts (T) : 29-39 Nm)

NOTE

It is necessary to check the balance of the ground blade. Insert a screwdriver to the center hole of the blade, and grind it so that the lower part of the blade becomes horizontal, while checking its balance.

9.8 Inspection of Each Part

Confirm that all the bolts, nuts, and screws are securely tightened.

10. TRANSPORTATION

! WARNING

Stop the engine and remove the plug cap. Do not leave nor transport this machine tilted.

1. Close the fuel cock. (See Section 8.2.2)
2. Detach the handle depending on the situation. Temporarily tighten the screws at the original positions if the handle is detached.

NOTE

See the separate engine instruction manual for the troubleshooting of the engine, and ask our distributor for adjustment if normal condition of the machine is not restored.

11. LONG-TERM STORAGE

11.1 Storage

Perform the following operations when the machine is left for 30 days or more without starting the engine.

! WARNING

Before working, stop the engine and remove the plug cap.

1. Exchange the engine oil and idle the machine for 5 minutes. (See Section 9.4)
2. Extract the fuel from the fuel tank and the carburetor. (See Fig. 36)
3. Clean the air cleaner. (See Section 9.5)

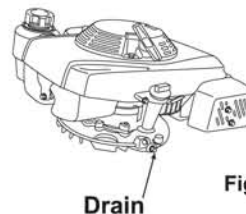

Fig. 36

NOTE

- See the engine instruction manual for details.
 - By discharging the residual fuel inside the carburetor, foreseeable troubles such as engine startup trouble caused by residual fuel can be eliminated.
4. Clean the blade and each part, and check tightening.
 5. Wipe the metal parts with a rag soaked with oil.
 6. Remove the ignition plug, and inject engine oil (5 - 10 cc) into the cylinder.
 7. Install the ignition plug after cleaning it. (See Section 9.6)
 8. Pull the recoil starter for a couple of times, and then pull it slowly up to a position where you feel heavy to pull it.
 9. Clean the grass bag.
 10. After using the machine, move it to a dry, un-dusty, flat place and cover it for storage.

NOTE

Repair or exchange abnormal parts, if any. Use only the specified parts.

12. DISPOSAL

- Dispose the waste engine oil, gasoline, or the disused lawn mower itself according to the relevant law of your country or the relevant regulations of your region, or consult our distributor.
- Never dispose them illegally since it may cause ground and / or water pollution.
- Dispose the rags used for wiping gasoline or oil, separated from general garbage.

13. TROUBLESHOOTING

Consult our distributor if normal condition of the machine cannot be restored. Do not disassemble the machine unnecessarily.

Phenomenon	Possible Cause	Ref. page
Engine does not start.	There is no fuel.	8.1.3
	Amount of engine oil is insufficient.	8.1.1
	Throttle lever is set at "STOP".	8.2.1
	Plug cap is removed.	8.2.1
	Excess gasoline is inhaled into cylinder.	
	Air cleaner is dirty.	9.5
Engine is hard to start. Engine power is weak.	Air cleaner is dirty.	9.5
	Carburetor is clogged.	
	Water has entered fuel tank or carburetor.	
	Fuel tank cap is removed.	
	Poor adjustment of throttle wire.	
Overheat of engine	Gasoline is dirty.	
	Clearance of ignition plug is not appropriate.	9.6
	Air cleaner is dirty.	9.5
	Cooling fan is dirty.	
	Amount of engine oil is insufficient.	8.1.1
Abnormal vibration	Recoil starter is clogged, etc.	
	Installation of blade and / or engine is loose.	9.8
	Unbalance of blade.	9.7.2

- a) Assembly instructions, initial adjustments and checks.
Please refer to follows.

3.6.4 Inspection and Maintenance
7. ASSEMBLY
9. INSPECTION AND MAINTENANCE

- b) Transport, handling and storage of the lawnmower.
Please refer to follows.

3.6.5 Transportation by Car
9. INSPECTION AND MAINTENANCE
10. TRANSPORTATION
11. LONG-TERM STRAGE

- c) Preparation of the lawnmower.
Please refer to follows.

8. OPERATION
9. INSPECTION AND MAINTENANCE

- d) Information regarding the lawnmower.
Please refer to follows.

3. SAFETY
4. NAME AND FUNCTION OF EACH PART

- e) The use of the lawnmower.
Please refer to follows.

3. SAFETY
8. OPERATION
9. INSPECTION AND MAINTENANCE

- f) Maintenance of the lawnmower.
Please refer to follows.

3. SAFETY
8. OPERATION
9. INSPECTION AND MAINTENANCE

CERTIFICATE OF CONFORMITY

TEL : +81-86-942-1122

FAX : +81-86-942-1120

I, the undersigned, **KAAZ CORPORATION** 387-1 SAIDAIJI GOMYO HIGASHI-KU, OKAYAMA 704-8588, JAPAN

certify that the lawnmower :

1. Category Combustion engine 2. Make _____
3. Type **TN2160SXAH-PRO** 4. Identification of the series _____
5. Engine - type GXV160 - manufacturer HONDA MOTOR CO., LTD.
 - max. output 3.2 kW (3,600rpm) - rotational speed during the tests 2,800 rpm
6. Examined by (laboratory reference) _____
7. Verbal proceeding No. _____

conforms to the specifications of Directive 2000/14/EC

Guaranteed sound power level 98 dB(A) - type of cutting device horizontally rotating type

- width of cut 53 cm - speed of rotation of the cutting device 2,800 rpm

MASAKI NONAKA



387-1 SAIDAIJI GOMYO HIGASHI-KU, OKAYAMA 704-8588, JAPAN
 Director of the Board, Production Division

Done at : OKAYAMA Date : Jan. 2. 2009



TEL : +81-86-942-1122
FAX : +81-86-942-1120

We

KAAZ CORPORATION

387-1 SAIDAIJI GOMYO HIGASHI-KU, OKAYAMA 704-8588, JAPAN

Name and address of the person authorised to compile the technical file, who must be established in the Community.

SABRE FRANCE

Address: B.P.N°96, 76203 DIEPPE CEDEX FRANCE
TEL: 02-32-90-52-40 / FAX: 02-35-84-19-84
JEAN-PIERRE STABLE

declare under our sole responsibility that the product

Technical documents deposited at ;

KAAZ CORPORATION

387-1 SAIDAIJI GOMYO HIGASHI-KU,
OKAYAMA 704-8588, JAPAN
MASAKI NONAKA

Designation of the machine(s) : Petrol-powered lawn mower

(Refer to the reverse) Type(s):

TN2160SXAH-PRO

to which this declaration relates is in conformity with the following standard(s) or other normative document(s)

(if applicable) following the provisions of : 2006/42/EC, 2004/108/EC, 2000/14/EC(ANNEX VI) - 2005/88/EC

References to harmonized standards : EN ISO 5395-1:2013 EN ISO 5395-2:2013

Notified Body :

TÜV SÜD Industrie Service GmbH

measured sound power level 97dB(A)

Westendstrasse 199 D-80686 Munich Germany

Guaranteed sound power level 98dB(A)

MASAKI NONAKA

387-1 SAIDAIJI GOMYO HIGASHI-KU, OKAYAMA 704-8588, JAPAN

Director of the Board, Production Division

Done at : OKAYAMA Date : Sep. 30. 2014

in the event of an alteration of the machine(s) not carried out in consultation and agreement with us this declaration shall lose its validity.